

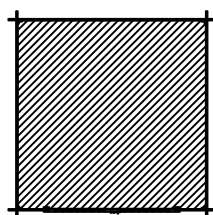

18 μ.

. 2105573739

E-mail: [info@kipogeorgiki.gr](mailto:info@kipogeorgiki.gr)

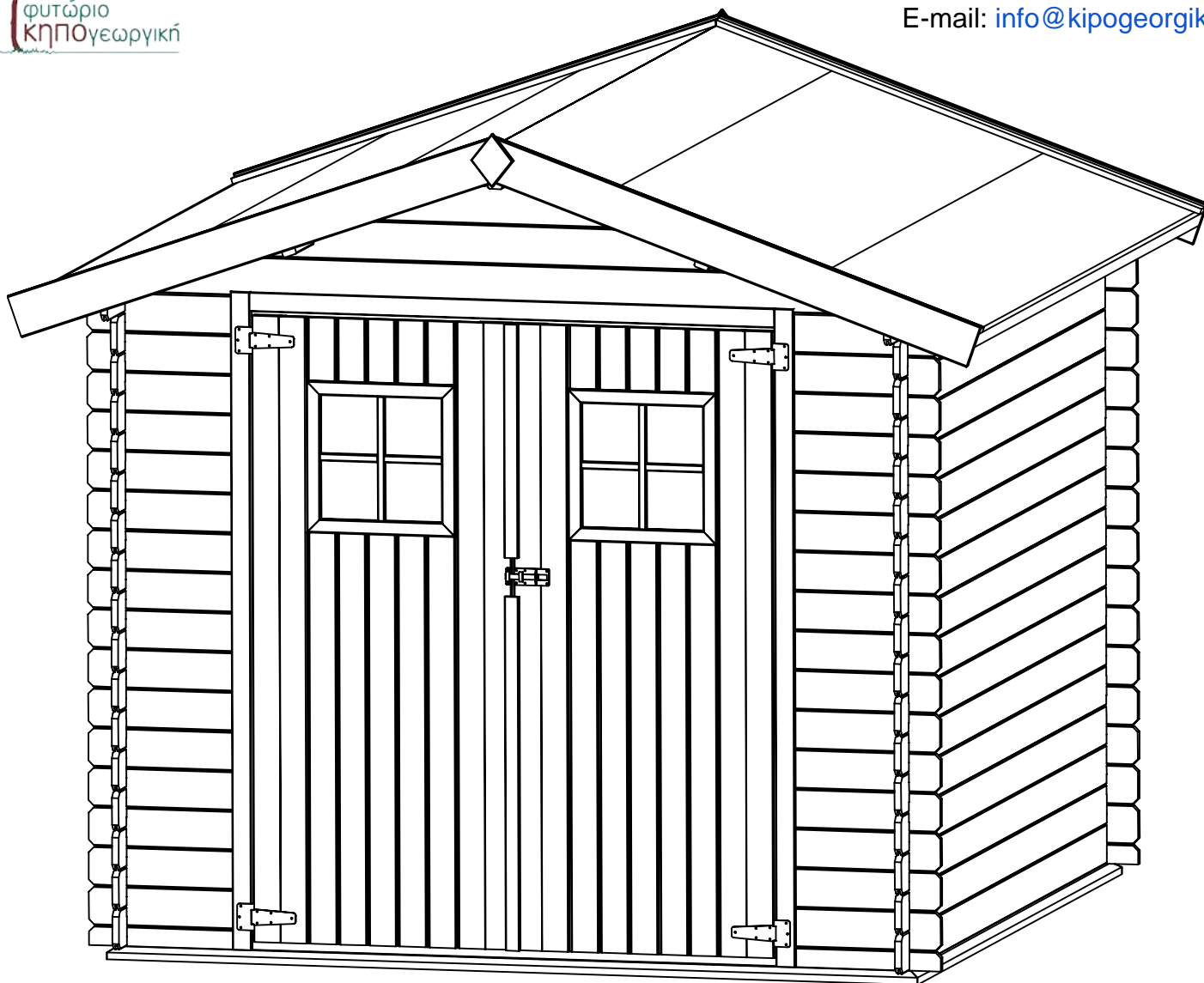



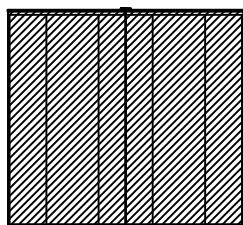



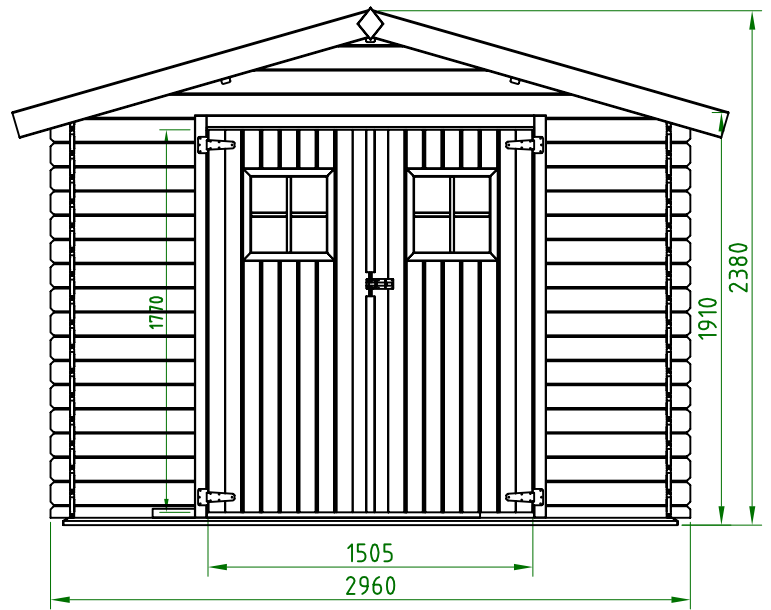
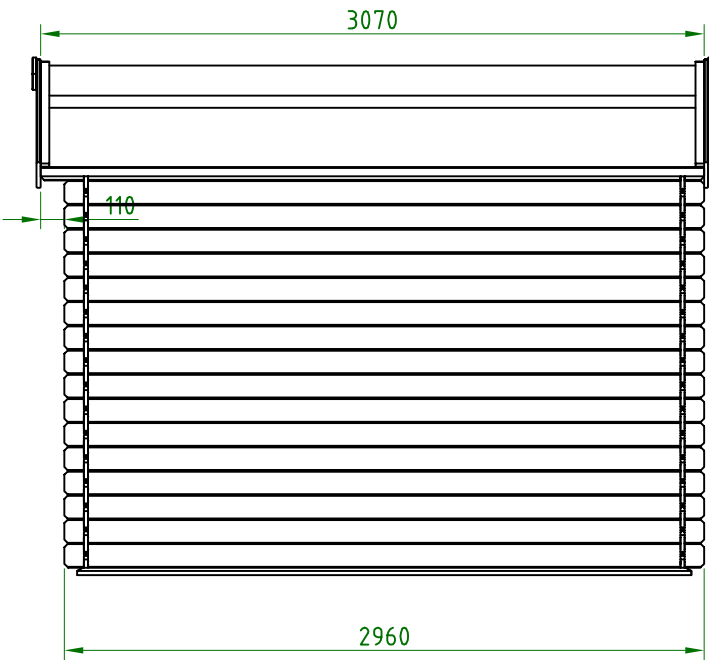
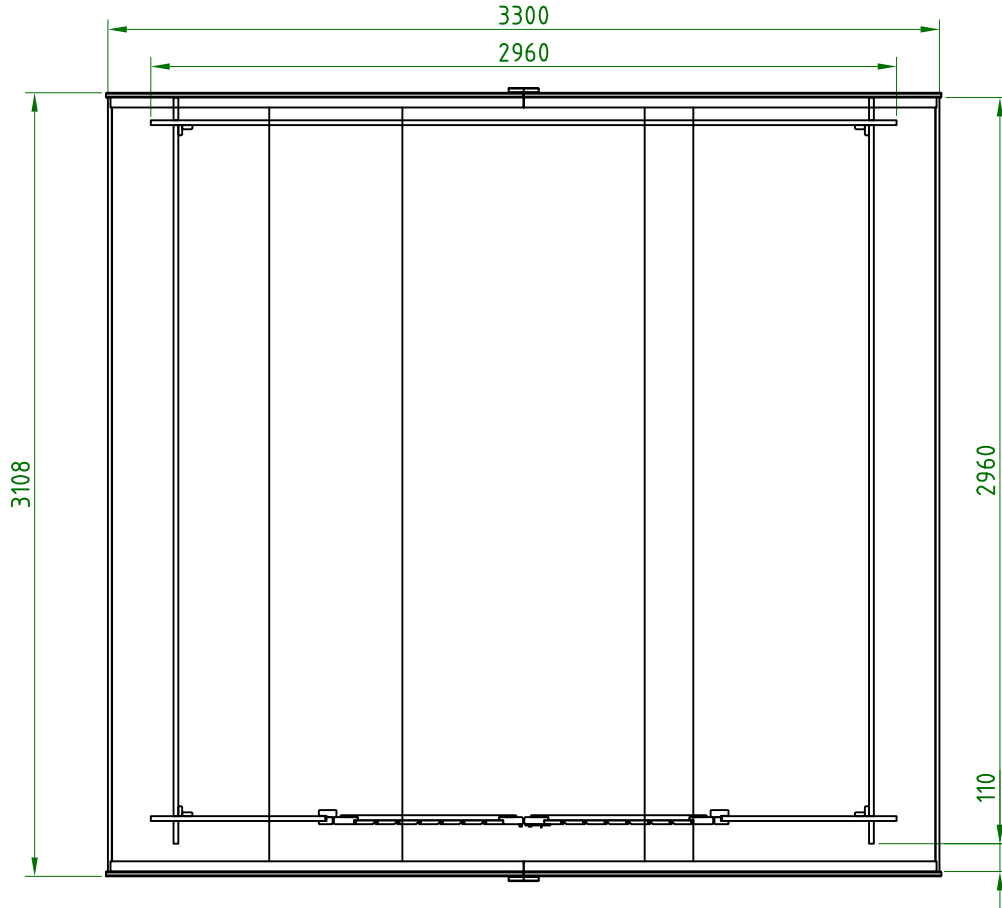



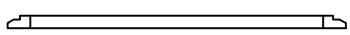
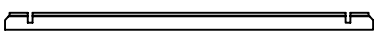
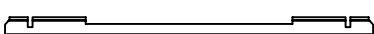

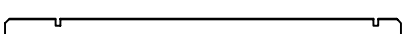
7,51m<sup>2</sup>

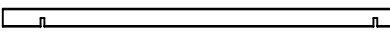



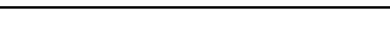
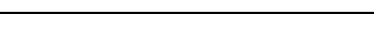

10,13m<sup>2</sup>





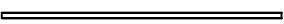

## Lista elementów do montażu - 16 407P

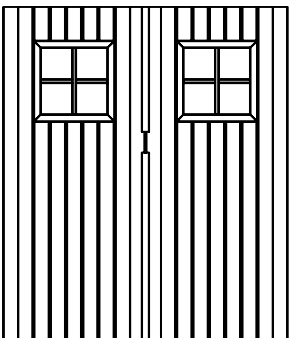
Nr	Rysunek elementu	Nazwa elementu	Wymiary (szer./wys./dł.)	Ilość
A1		Legar profilowany	50x90x2841mm	4
B1		Deska ścienna	19x67x2960mm	1
B2		Deska ścienna	19x67x2960mm	1
B3		Deska ścienna	19x123x2960mm	48
B4		Deska ścienna	19x123x3070mm	2
B5		Deska ścienna	19x123x692mm	32
C		Panel ścienny	19x448x2960mm	2
D		Krokiew	40x95x3070mm	3
E1		Listwa wzmacniająca	16x40x2741mm	2
E2		Listwa wzmacniająca	16x40x200mm	2
E3		Listwa wzmacniająca	16x40x90mm	2
F		Deska dachowa	16x98x1700mm	70
G1		Listwa mocująca	16x40x3070mm	4
G2		Listwa mocująca	16x40x1705mm	4
H		Listwa maskująca	19x123x1724mm	4
I		Element dekoracyjny	19x150x120mm	2



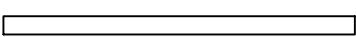

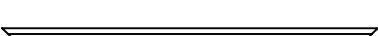

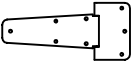
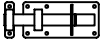
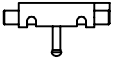
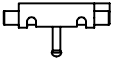

## Lista elementów do montażu

Nr	Rysunek elementu	Nazwa elementu	Wymiary (szer./wys./dł.)	Ilość
J1		Listwa spinająca	16x40x1851mm	4
J2		Listwa spinająca	16x40x1850mm	4
K1		Ościeżnica	56x70x1860mm	1
K2		Ościeżnica	56x70x1860mm	1
K3		Ościeżnica	56x70x1625mm	1
L		Drzwi podwójne + listwy przyrytkowe	2 skrzydła - 750x1770mm 1 listwa - 16x40x660mm 1 listwa - 16x40x1000mm	1

## Lista elementów do montażu

Nr	Rysunek elementu	Nazwa elementu	Wymiary (szer./wys./dł.)	Ilość
M1		Legar	50x90x2661mm	5
M2		Deska podłogowa	16x98x2731mm	31
M3		Listwa przypodłogowa	22x30x2741mm	3
M4		Listwa przypodłogowa	22x30x558mm	1
M5		Listwa przypodłogowa	22x30x558mm	1

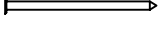
## Lista załączonych okuć

Nr	Rysunek elementu	Nazwa elementu	Ilość
		zawias	4
		zasuwka + zaczep	1
		zasuwka blokująca (górna)	1
		zasuwka blokująca (dolna)	1
		wkręty ocynk żółte 3x30mm	180
		wkręty ocynk żółte 3x40mm	70
		wkręty ocynk żółte 4x40mm	30
		wkręty ocynk żółte 4x70mm	12
		wkręty ocynk żółte 5x90mm	30
		gwoździe pierścieniowe ocynk 2.5x40mm	710
		gwoździe papowe 2.5x16mm	450

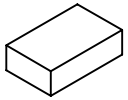

1 pustak 25x40xh12 - 35szt

1

Element A1 - 4szt

2

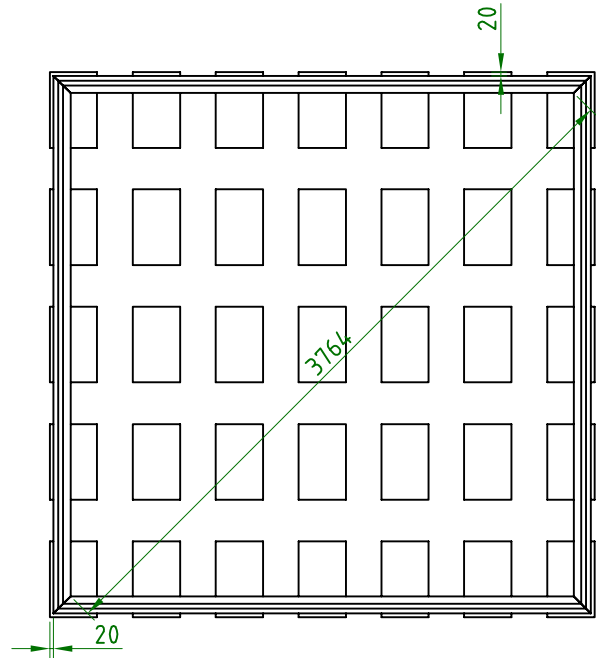
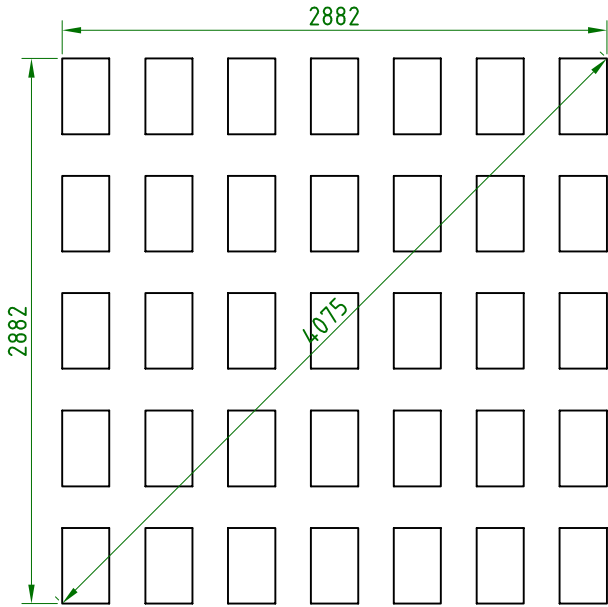

Element M1 - 5szt  
Wkręty 5x90mm - 28szt

3

Element M2 - 31szt  
Gwoździe 2.5x40mm - 500szt

4

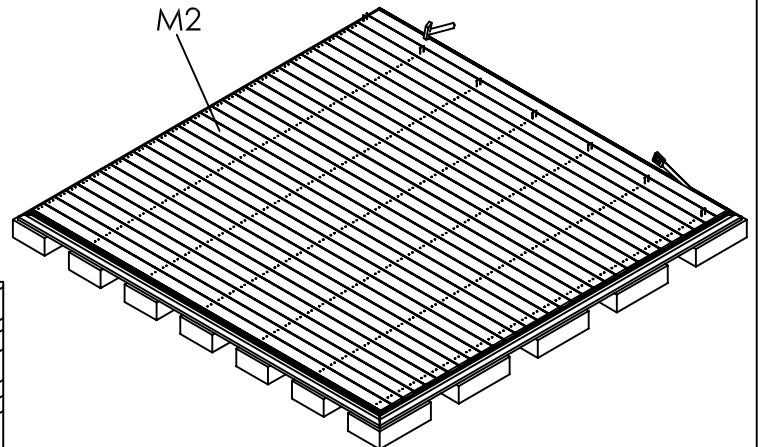
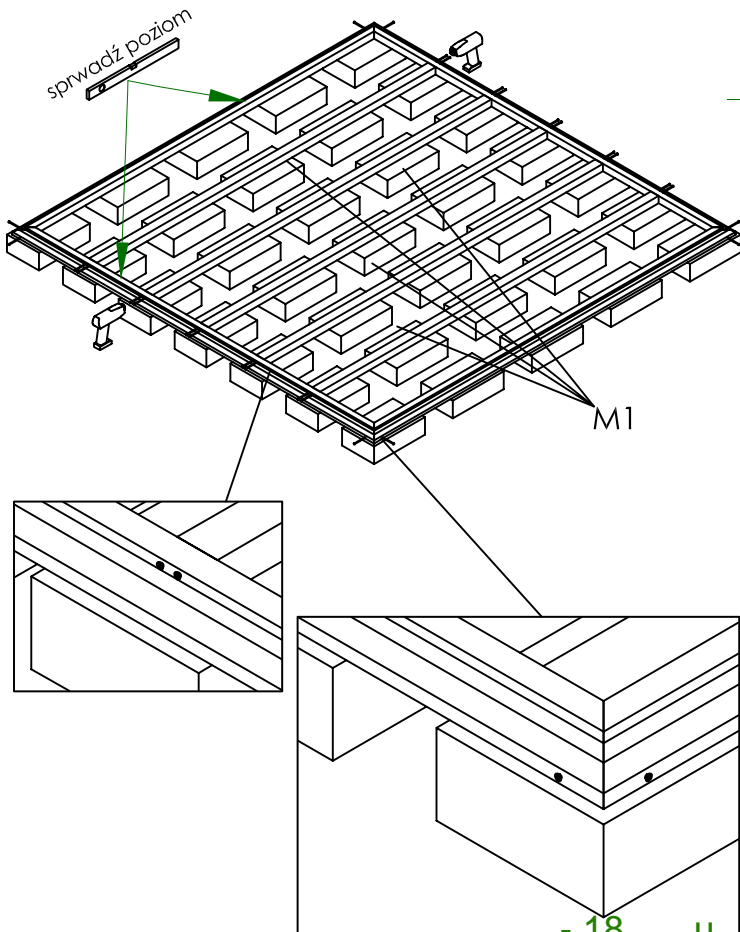

[www.kipogeorgiki.gr](http://www.kipogeorgiki.gr)

Element B.1 - 1szt  
 Element B.2 - 1szt  
 Element B.3 - 2szt  
 wkręty 4x40mm - 28szt

5

Element B.3 - 45szt  
 Element B.5 - 32szt

6

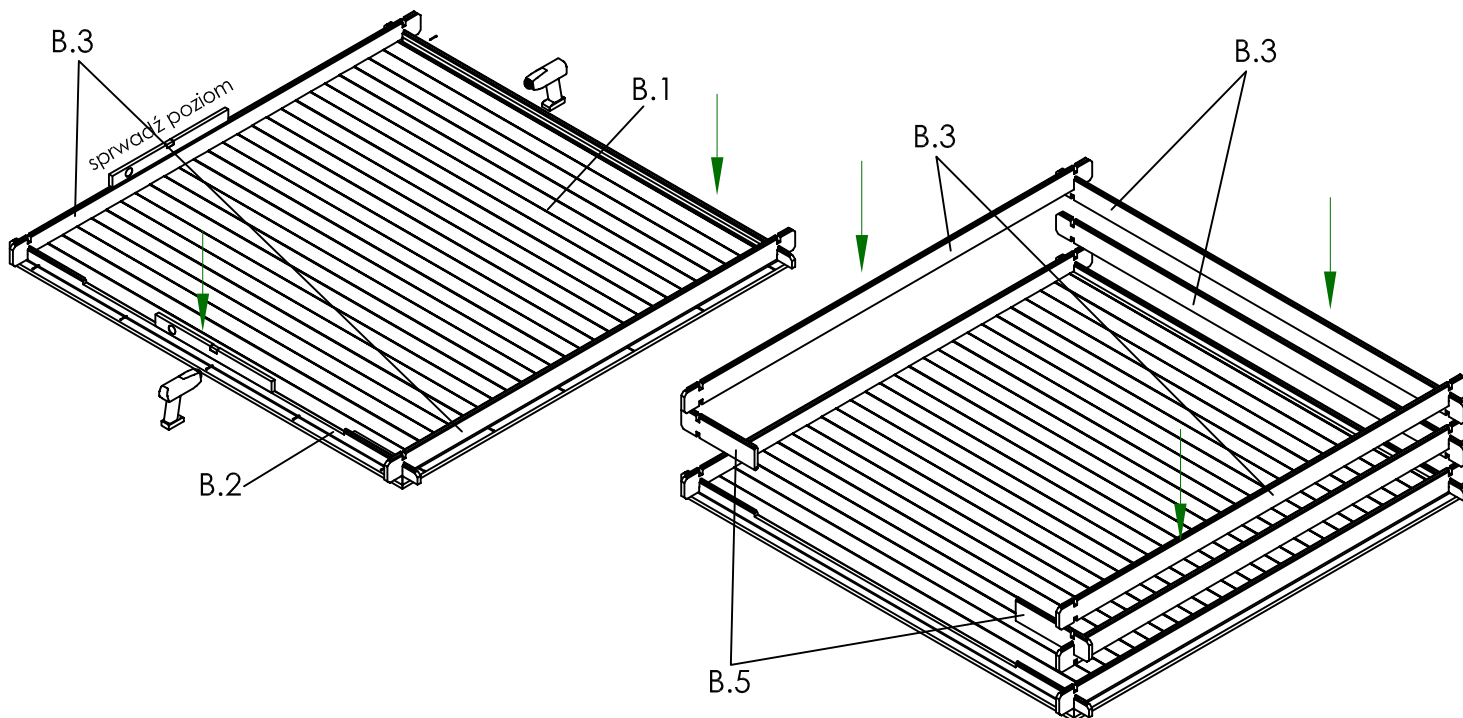

Element B.4 - 2szt  
 Element C - 2szt  
 Element K1 i K2 - 2szt  
 Element K3 - 1szt

7

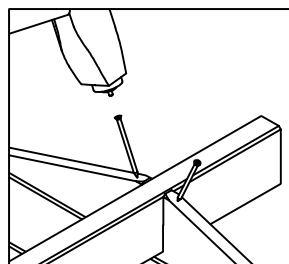

Element D - 3szt  
 wkręty 4x70mm - 12szt  
 wkręty 3x30mm - 12szt

8

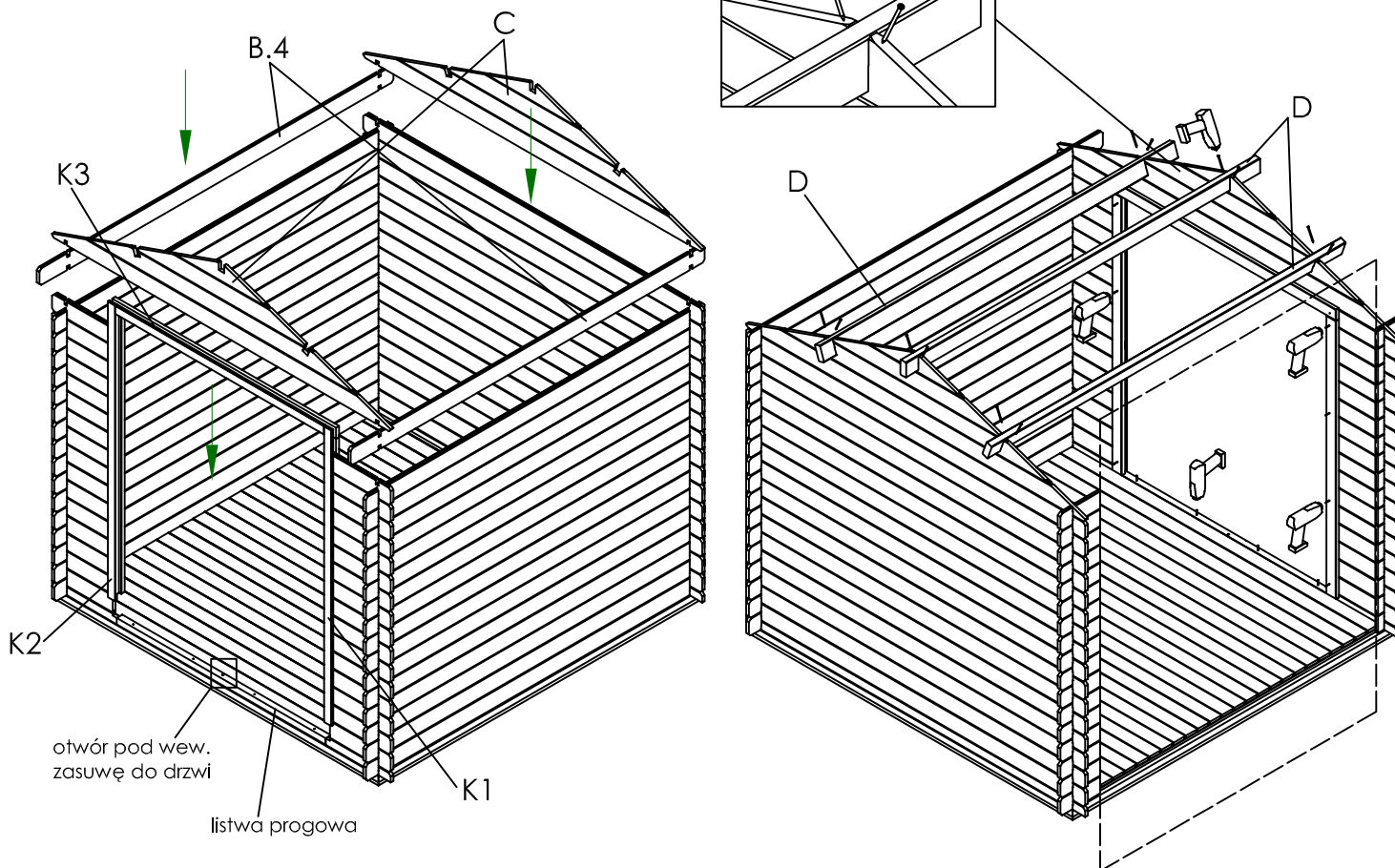

Element F - 70szt  
gwoździe 2.5x40mm - 210 szt

9

Element G1 - 4szt  
wkręty 3x30mm - 30szt

10

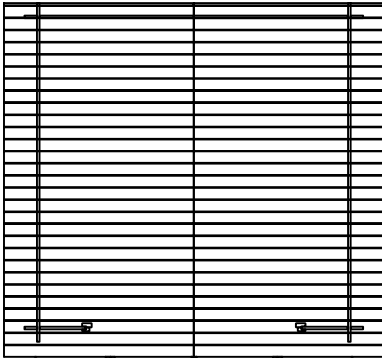
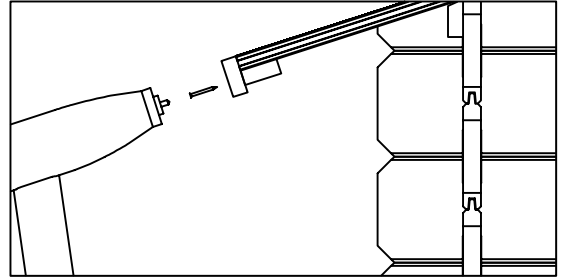
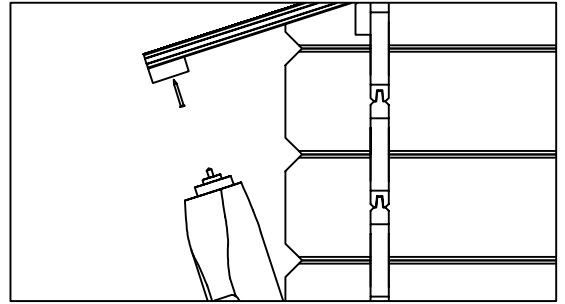
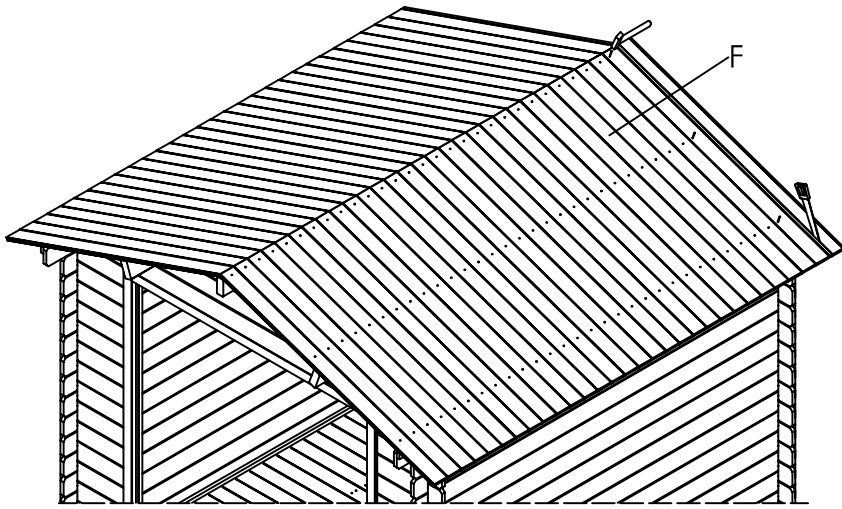

kierunek układania

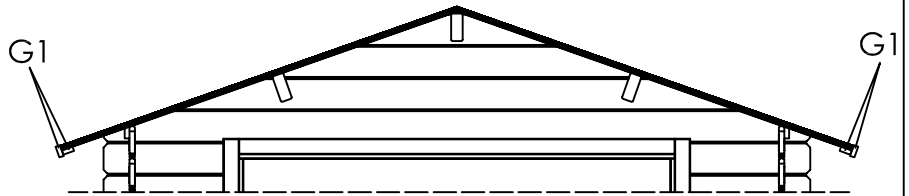

Element H - 4szt  
Element G2 - 4szt  
wkręty 3x30mm - 55szt  
gwoździe papowe 2.5x16mm - 400szt

11

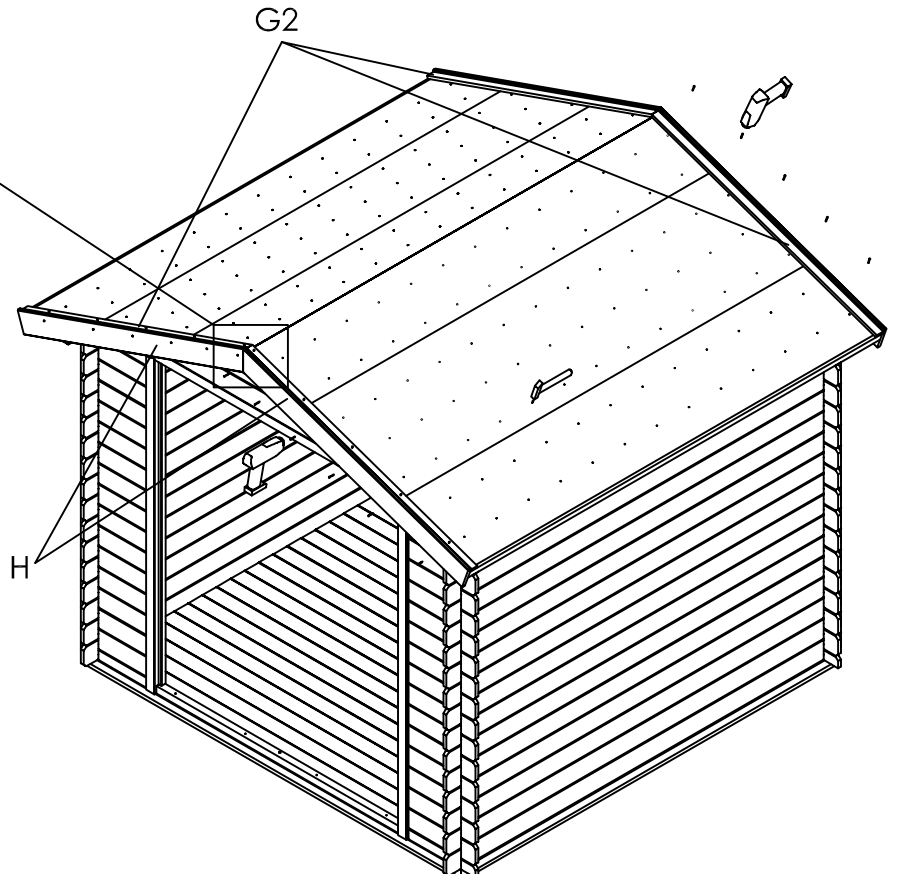
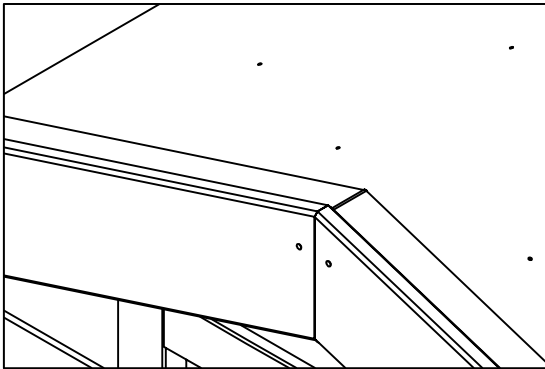

Element - 2szt  
 Element L - 2szt  
 wkręty 3x30mm - 4szt

12

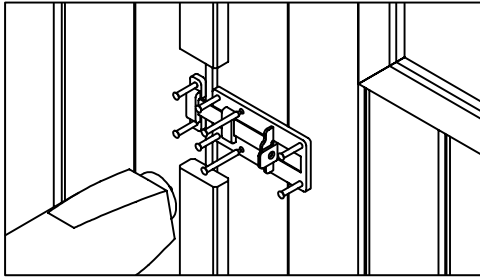

zasówka - 1szt  
 wkręty 3x30mm - 8szt

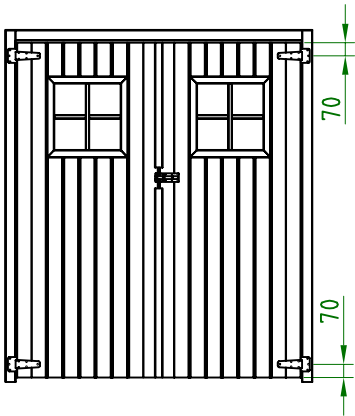

zawiasy - 4szt  
 wkręty 3x40mm - 40szt

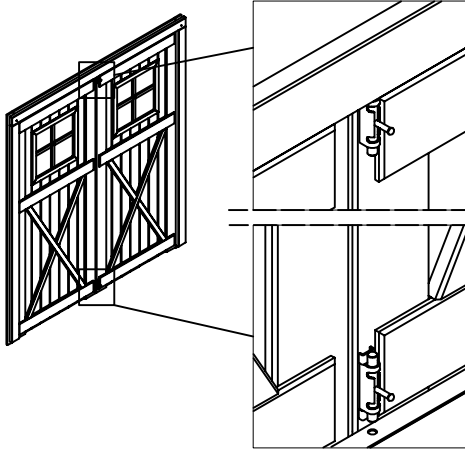
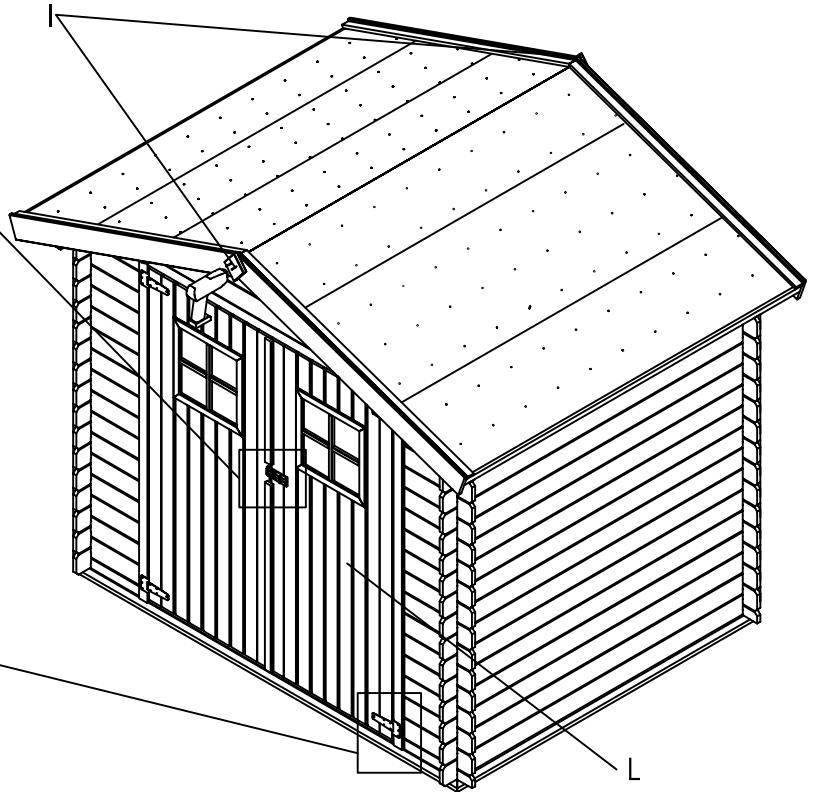
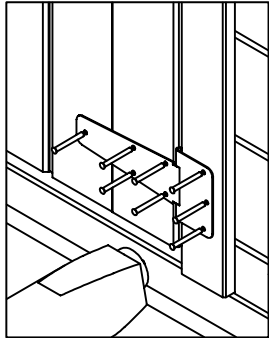

zasówka - 1szt  
 wkręty 3x40mm - 2szt

zasówka - 1szt  
 wkręty 3x40mm - 2szt

Element M3 - 3szt  
 Element M4 - 1szt  
 Element M5 - 1szt  
 wkręty 3x40mm - 25 szt

14

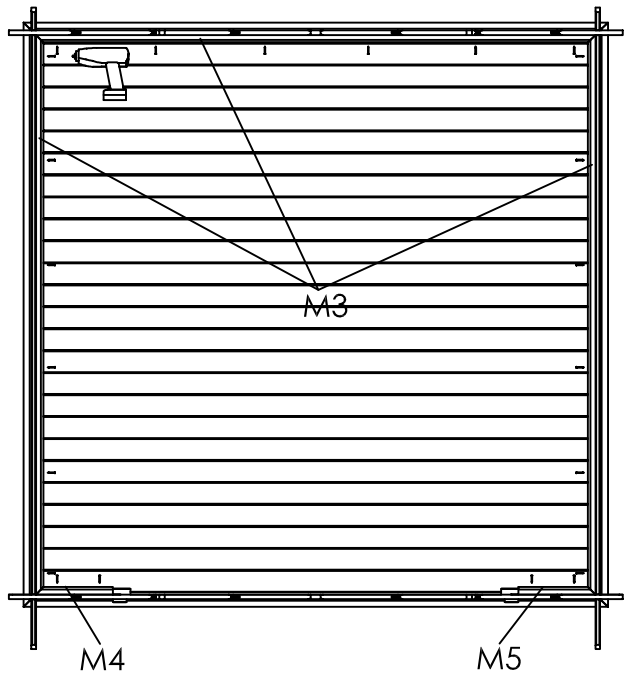

Element J1 - 4szt  
 Element J2 - 4szt  
 wkręty 3x30mm - 70 szt

13

