



ΦΥΤΑ - ΜΗΧΑΝΗΜΑΤΑ - ΕΡΓΑΛΕΙΑ

18ο χλμ. Εθνικής Οδού ΑΘΗΝΩΝ-ΚΟΡΙΝΘΟΥ

Τηλέφωνο: 2105573739

E-mail: info@kipogeorgiki.gr

CONTENTS

General conditions	14
Material requirements	15
Terms	16
Estimating shingle requirements	16
Roof preparation	18
Shingle application	21

GENERAL CONDITIONS

- IKO assumes no responsibility for leaks due to improper application, or failure to properly prepare the roof surface. Shingles may not be installed directly over insulation; flow-through ventilated air space must be provided between the insulation and the nailable deck.
- Do not mix different production dates/codes on the same roof surface.
- Colour shading is inherent to shingles and is not a defect. In order to minimise shading, shingles should be picked and mixed randomly from different bundles and placed across and diagonally up the roof.
- Do not stack the shingles up the roof!
- Do not remove the tape from the back of the shingles. It is for packaging purposes and not for sealing.
- However, release film on the back of self-adhesive shingles must be removed during application. (Figure 7 - 7)
- The factory applied sealing strip will become effective when exposed to the heat of the sun. Hand sealing is necessary for cold weather and steep slope application. Plastic cement must be approved by IKO to be compatible with IKO shingles.
- Bend bundle before opening for easier separation.
- Caution: During sunny, hot periods, avoid stepping on shingles on the sunny side of the roof to prevent marking.

MATERIAL REQUIREMENTS

- **Shingles:**
IKO's selection of more than 70 different types and colours of fibreglass based oxidised and APP modified bitumen shingles.
- **Underlays:**
IKO Armourbase: a range of watertight roofing membranes.
- **Valley Coverings** (for Open Valley Method):
IKO Armourvalley: a 4 mm APP modified membrane in matching shingle colours, or metal flashing.
- **Metal flashings:**
Metal flashings are made out of corrosion resistant materials, which protect the drip edge at eaves or rakes. Metal flashings are also used to interconnect the shingles roof cover with some roof details such as chimneys, dormers, slope transitions, wall connections, valleys, etc.
- **Fasteners:**
Corrosion resistant nails (galvanised clout nails) 25 mm in length and a head diameter of 10 mm. The shaft should be 3 mm in diameter and barbed. Laminated shingles and nailing of hips and ridges require nails 30 mm in length.
- **Bituminous mastic:**
IKO Shingle Stick, **IKO Plastal Stick** or an IKO approved plastic mastic.
- **Vents:**
IKO Armourvent: a range of sufficient vents to satisfy minimum venting requirements.
- **Starterstrip**

TERMS

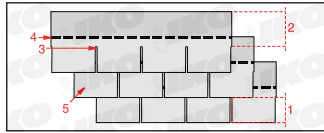

1. Exposure • 2. Headlap • 3. Cut-outs
4. Self Sealing Strip • 5. Tabs

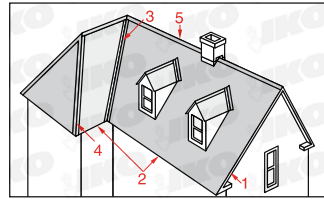

1. Rakes • 2. Eaves • 3. Valleys
4. Hips • 5. Ridges

ESTIMATING SHINGLE REQUIREMENTS

I. FOR THE ROOF DECK

Shingle exposure is according to the roof pitch as displayed in the table below.
Shingles may not be applied on roof pitches not specified.
Certain countries may have different regulations.
Check local building codes.

II. FOR THE HIPS AND RIDGES

A good approximation is to order an extra 10 - 15 % material (depending on the amount of roof details) for coverage of the hips, ridges and starter strip.
When applying round shaped or laminated shingles be sure to order rectangular shingles in a matching colour to cover hips and ridges.

No time for cutting?

Choose **Starterstrip** (Figure 1a) when there is no time for cutting or when laminated shingles are being installed.



Shingle type	Roof pitch	Exposure	Roof coverage/ Bundle	± kg/m ²
Superglass – 3T	15° - 85°	14,3 cm	3,00 m ²	9,6
Superglass – Biber	15° - 85°	14,3 cm	3,00 m ²	9,2
Superglass – Hex	15° - 90°	13,4 cm	3,00 m ²	7,8
Armourglass PLUS	15° - 85°	14,3 cm	2,00 m ²	11,6
Victorian PLUS	15° - 85°	14,3 cm	2,00 m ²	11,1
Diamant PLUS	15° - 85°	11,2 cm	2,00 m ²	11,1
ArmourShield PLUS	15° - 90°	13,4 cm	2,00 m ²	8,0
DiamantShield	15° - 90°	11,2 cm	2,46 m ²	11,1
Monarch	15° - 85°	14,3 cm	2,58 m ²	12,5
Monarch – Diamant	15° - 85°	11,2 cm	2,46 m ²	12,0
Cambridge Xpress	15° - 85°	15,0 cm	3,10 m ²	11,6
Cambridge Xtreme 9,5°	9,5° - 90°	15,0 cm	3,10 m ²	11,8

ROOF PREPARATION

I. ROOF DECK (Figure 2)

The roof deck must be smooth, firm, dry and securely fastened.

The deck should be made of good quality plywood, sheathing boards or nonveneer structural panels (wafer or strand board). Wooden boards can be maximum 15 cm wide. The thickness of the deck depends on the span between the beams. Check your local building code regulations. All wood products must be properly conditioned to be at moisture equilibrium. Decking should be installed in a staggered manner and sufficiently supported. Failure to use proper decking material, which can provide a rigid deck surface, can result in deck movement which can damage the shingles.

As IKO we have the best experience with OSB in tongue and groove. When wooden planks are not dry enough, the wood is moving and creates gaps, which can cause wrinkling on the shingles roof.

II. VENTILATION (Figure 3a + 3b)

It is essential to allow heat dissipation and water vapour to escape the roof system through proper ventilation. Therefore, air must be able to circulate freely between insulation and the nailable roof deck, from the eaves to the ridges. On roof pitches 15°- 40° (Cambridge Xtreme 9,5°: 9,5° - 40°) the minimum net free ventilation area is 33 cm², on 41°- 85° min. net free ventilation area is 16 cm² for each 1 m² of insulated ceiling area located under the roof, always divided evenly between the eaves (for air intake) and the ridge (for air exhaust).

Example:

100 m² insulated roof surface with pitch < 40°

= NFA = 3,333 cm² (100 m²/300)

=> 1667 cm² intake & 1667 cm² exhaust

Efficient ventilation is ensured when using as exhaust vents:

- Minimum 1 roll of **Armourvent MULTI/MULTI PLUS**
(1667 cm²/275 cm²/m = 6,06 m => 1 roll)
- Minimum 6 EA **Armourvent RIDGE PLUS**
(1667 cm²/258 cm²/m = 6,46 m/1,22m/EA = 5,3 EA rounded up => 6 EA)
- Minimum 6 EA **Armourvent STANDARD**
(1667 m²/322 cm²/EA = 5,2 EA rounded up => 6 EA)
- Minimum 56 EA **Armourvent SPECIAL**
(1667 cm²/30 cm²/EA = 55,6 EA rounded up => 56 EA)
- Minimum 2 **Airhawk 14"**
(1667 cm²/852 cm²/EA = 1,96 EA rounded up => 2 EA)
or 3 **Airhawk 12"** (1667 cm²/613 cm²/EA = 2,72 EA rounded up => 3 EA)

III. UNDERLAY

Underlayment is not mandatory in gardenhouse or leisure house application, but IKO will be not responsible for water infiltration caused by driven rain, wind and dust through the shingles. Install as flat as possible to prevent unevenness from being projected in the shingle surface. Install parallel to the eaves.

Slopes 9,5°- 20°

Option 1 (Figure 4a I): it is advised to cover the entire roof deck with **IKO Armourbase Pro Plus** or **-Stick** adhesive underlay or a similar modified base sheet which will seal the entire deck. Follow a 10 cm horizontal overlap for the consecutive rows while end laps must be 15 cm for **Armourbase Stick** or 30 cm for **Armourbase Pro Plus** and vertically sealed with **IKO Shingle Stick**.

Option 2 (Figure 4a II): use **IKO Armourbase Pro** or **ECO** underlay or a similar base sheet, to provide a double coverage of underlay to the roof deck. Cut a starter strip 50 cm wide and lay succeeding courses fastened with 50 cm horizontal laps and 30 cm end laps.

Slopes 21°- 85° (Figure 4b)

The entire roof deck should be covered with **IKO Armourbase** underlay or an approved shingle underlay. The underlay should be installed parallel to the eaves with a min. 10 cm horizontal lap and 15 cm end laps. On **IKO Armourbase Pro**, **- Pro Plus**, **- Stick** and **- ECO** there are 10 cm lines on the rolls for easier overlapping. Secure the underlay with only enough nails to hold it in place.

Slopes 85°- 90°

No underlay required. Only self-adhesive shingles can be applied.

IV. VALLEYS

One may follow either the Open, Woven or Closed Cut method for shingle application in the roof valleys. Valley preparation depends on the method:

• Open Valley Preparation (Figure 8a).

Cover the valleys with 1 m wide underlayment, **IKO Armourbase** (1). Vertical laps must be 30 cm and glued (2). The end laps from the roof deck underlay must overlap the valley by 15 cm (3). Finish the valleys by applying the **IKO Armourvalley** or metal flashing with metal sheet not less than 60 cm wide, 0,40 mm thick and corrosion resistant. Place on top of the underlay in the valleys (4). Nail the **IKO Armourvalley** at 40 cm intervals 2,5 cm from the edge. If lapping is unavoidable it must be 30 cm and glued or torched (5). Metal flashing should be fastened every 25 cm and overlaps should be 30 cm and glued.

Attention:

For low slope valleys use **IKO Base** for underlayment in the valley. This underlayment must be applied with good mechanical fastening (nails or screws every 20 cm in all directions). Afterwards the **IKO Armourvalley** must be fully torched on it.

• **Woven or Closed Cut Valley Preparation** (Figure 8e, 8f)

Prepare the valley with one layer of **IKO Armourbase Stick** adhesive underlay with 30 cm laps. Alternatively, use a layer of **IKO Armourbase Pro**, **Pro Plus** or **Eco** or an approved shingle underlay, nailed 2,5 cm from the edge. Laps should be 30 cm and glued.

V. EAVES PROTECTION (Figure 4c)

In climates where average winter temperatures are -1°C , eaves should be protected against ice damming which can cause water to back up the roof under the shingles. Apply **IKO Armourbase Stick** adhesive underlay from the eaves to the least 60 cm beyond the inside wall line. Use 10 cm horizontal laps and 15 cm end laps.

Alternatively, use **IKO Armourbase Pro Plus** with standard horizontal overlap or use **IKO Armourbase Pro** or **Eco** underlay and provide a double coverage of underlay to the eaves (Figure 4a II). When **IKO Armourbase Pro** or **Eco** is used, cut a starter strip 50 cm wide and lay succeeding courses glued with 50 cm horizontal laps and 30 cm end laps to a distance 60 cm beyond the inside wall line.

VI. DRIP EDGES (Figure 4a I)

Metal flashings used for the rakes and eaves of the roof should be made of corrosion-resistant material which extends at least 8 cm from the edges and bends downward over them. Metal flashings should be applied over the underlay at the rakes (4) and under the underlay at the eaves. For other roof details where metal flashing are needed, particular application methods are used in order to provide the roof water tightness.

VII. CHALK LINES (Figure 7)

Chalk lines provide visual guides that help align the shingles horizontally and vertically. They also help roofers align shingles on each side of a dormer or chimney. Horizontal lines can be snapped every 4 to 5 courses (1) and a vertical line (2) should be used on long shingle runs, where a line is snapped in the centre of the run and shingles are applied to the left and right of the line. All chalk lines are to be considered as guiding lines, not application lines.

SHINGLE APPLICATION

I. NAILING & SEALING

Proper fastening is essential for a good roof. Using staples or screws for fixing roof shingles is forbidden. Drive the nails straight so that the nail heads are flush with, but not cutting into the shingle surface (Figure 5). Always nail 2,5 cm above the cut-out and 2,5 cm from each edge. For correct positioning and nail quantities per type of shingle and roof slope, see Figure 6a. Note that steep slope application ($> 60^{\circ}$) or high wind areas require extra nails and hand sealing with **IKO Shingle Stick** as shown in Figure 6b. During cold weather application extra glue must be added in the same manner. Extra mastic on self-adhesive shingles should only be applied on steep slopes ($60^{\circ} - 90^{\circ}$) in cold weather. In high wind areas the tabs of each shingle should be glued for at least the top five courses of the roof. Plastic cement should be applied in amounts no greater than 25 mm in diameter and used sparingly.

Caution:

Shingles should seal to the underlying course when the factory applied asphalt sealant is sufficiently warmed by the heat of direct sunlight. When application conditions might limit the effectiveness of the sealing strip, such as in cold weather or in areas subject to high winds or blowing dust, shingle adherence should be ensured through manual sealing as described above.

Nail position for laminated shingles: **CAMBRIDGE XPRESS LANE** = NAILING LINE.

STARTER STRIP (Figure 1a)

Prepare the starter strip by cutting off the shingle tabs along a line level with the top of the cut-outs. Begin the starter strip by cutting the strip half a tab short so that its joints will not line up with the joints of the first course of shingles. The starter strip should overhang the eaves by 6-10 mm and the rakes where applicable (Figure 7-3). For laminated shingles use rectangular shingles or **Starterstrip** for **Cambridge Xpress** and **Cambridge Xtreme 9,5°**.

FIRST COURSES & APPLICATION PROCEDURE (Figure 7)

• **First course** (4):

Start with a complete shingle applied flush with the starter strip at rake and eaves. Nail as shown in Figure 5 and continue across the roof with full shingles.

• **Second course** (5):

Cut half a tab from a shingle and start at the rake end. Nail the shingle so that the lower edge of the tabs is flush with the top of the cut-out of the shingle in the first course.

• **Third and succeeding courses** (6):

Start the third course with a shingle from which a full tab has been cut. Cut off an additional half tab for each succeeding course. For maximum protection against wind driven rain, glue the shingle at the rake edges.

Attention:

When applying laminated shingles, trim off 25, 50, 75 ... cm respectively from the left end of the first shingle in the second (5), the third (6), the fourth (7), ... course. Note that other offsets between 10 - 25 cm are permitted.

II. SHINGLE APPLICATION IN VALLEYS

Open Valley Method (Figure 8b, 8c, 8d)

Snap two chalk lines from the ridge to the eaves 8 cm apart increasing in width by 1 cm per meter toward the eaves (1). Trim the shingles to these lines and cut a 5 cm triangle off the top corner to direct the water into the valley (2).

Glue the valley end of each shingle with **IKO Shingle Stick** (3) and nail the shingles 5 cm back from the chalk line (4).

Woven Valley Method (Figure 8f)

Install the shingles through the valley intersection. The last shingle should extend at least 30 cm onto the intersecting roof surface (1) fastened with an extra nail at the upper corner of the shingle (2). Press the shingles tightly into the valley before nailing. No nailing within 15 cm of the valley centreline.

Closed Cut Method (Figure 8e)

For best performance: start applying on roof plane with the lower slope or lesser height (= smallest surface). The starter strip and the first course of shingles should be woven (1) (extend + 25 cm onto adjoining roof plane). Extend the end shingle at least 30 cm on the adjoining roof. Do not nail within 15 cm of valley centerline. Use one extra nail (2) at the end of each shingle crossing the valley. After completing this roof plane, snap a chalk line (3) 5 cm from centreline on roof plane still to cover. Apply the shingles onto second plane, trim shingles to the line and cut a 5 cm triangle (4) off the top corner to direct the water into the valley.

Glue the valley end of each shingle with **IKO Shingle Stick** (5).

III. HIPS AND RIDGES (Figure 9a + 9b)

Adjust the last few courses of shingles so that the ridge capping will adequately cover the top courses of shingles equally on both sides of the ridge. Cut rectangular and diamond shaped shingles into individual pieces by dividing the shingle at the cut-outs (1). (ArmourShield PLUS: (A) is visual part, (B) is covered part.) (Figure 9a).

Apply the hip and ridge shingles double thickness by stacking two pieces and bending them over the hip or the ridge. In cold weather warm the shingle before bending.

Nail the capping 16 cm from the tab edge (2) and 2,5 cm from each side (3), exposing each piece 14 cm. Start application from the end of the ridge opposite the direction of the prevailing winds (Figure 9b)

For **Cambridge Xpress** and **Cambridge Xtreme 9,5°** to obtain a 3D-effect apply capping shingles by stacking 2 pieces on top of one another (slightly offsetting the shingles by 2,5 cm in exposure). (Figure 9a - D)

IV. FLASHINGS

Chimneys (Figure 10a) - Step Flashing (Figure 10b)

V. REROOFING

Example of reroofing with **Cambridge Xpress** shingle roof (Figure 11)

Slope less than 15° reroofing shingle over shingle with **Cambridge Xtreme 9,5°** is not recommended.



**Ask for our
guarantee system...**



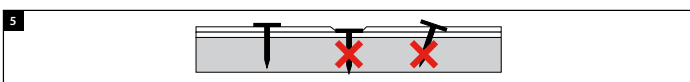
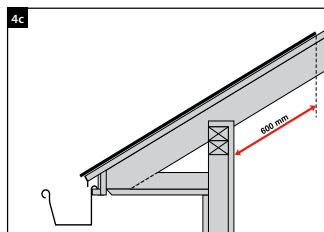
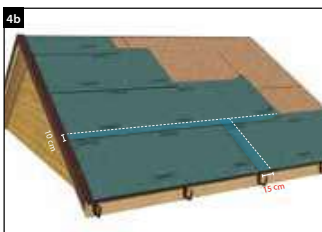
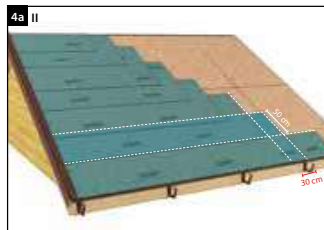
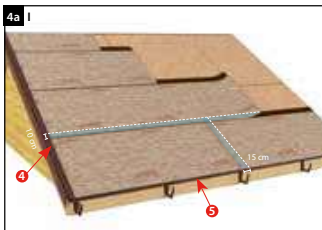
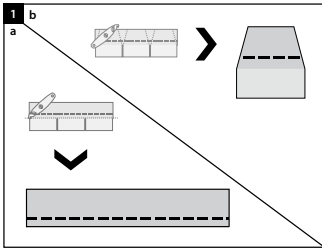

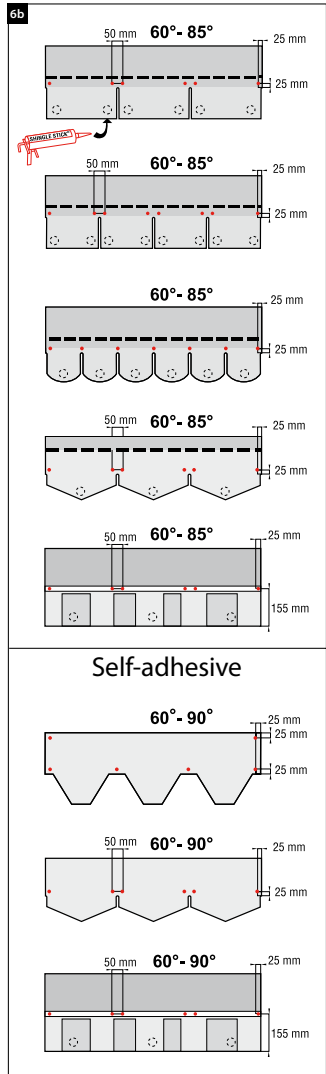
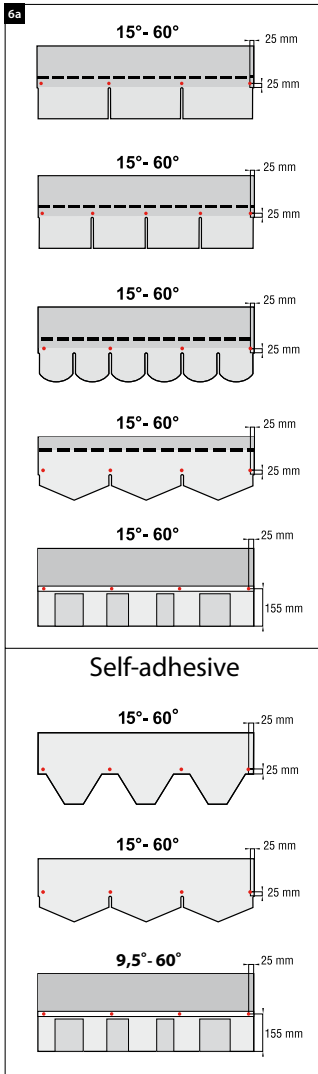

7

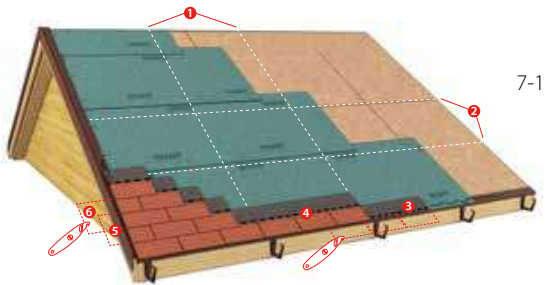

7-1

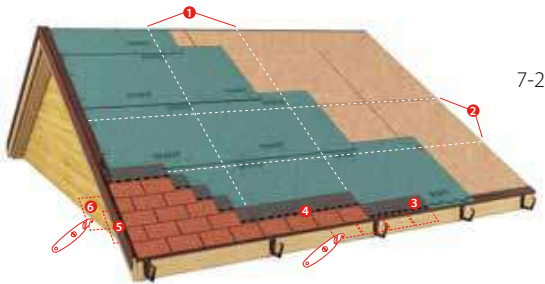

7-2

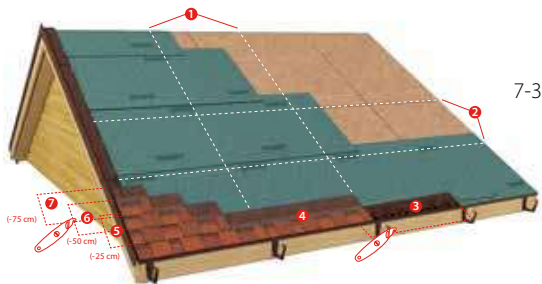

7-3

7

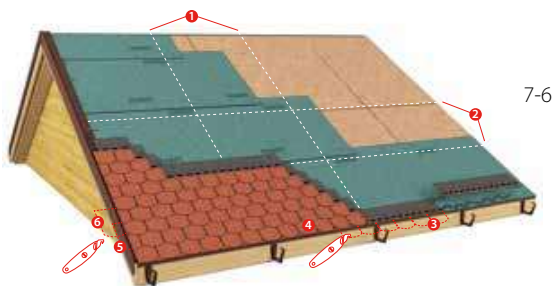
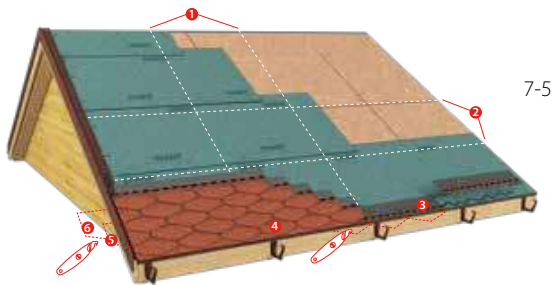
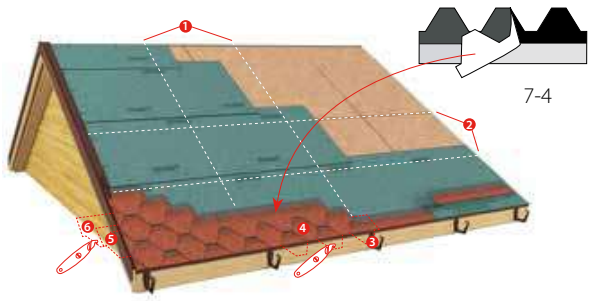

7

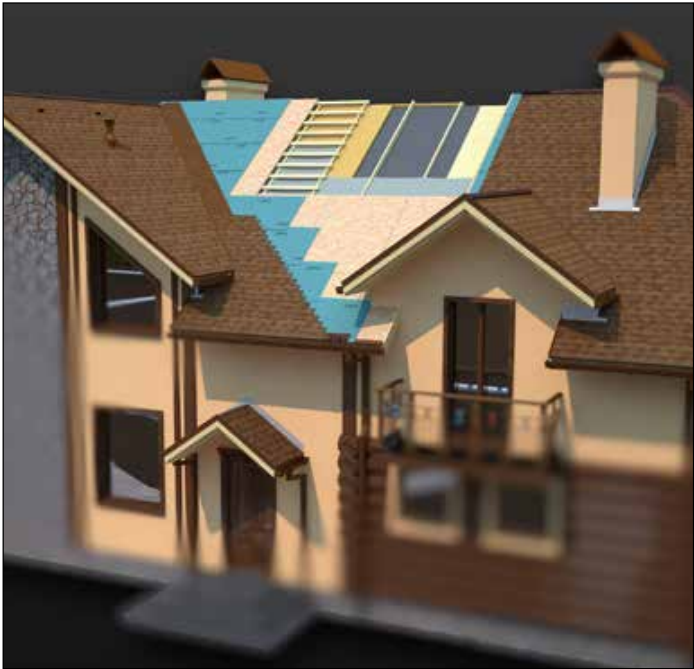
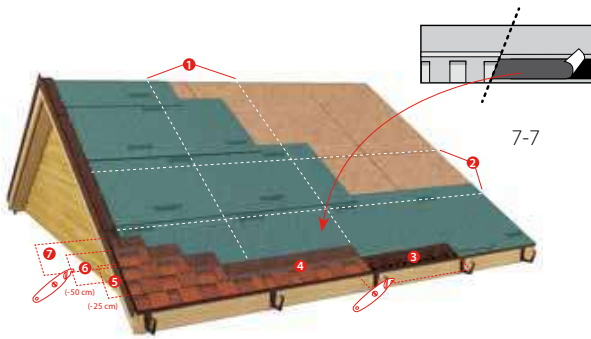

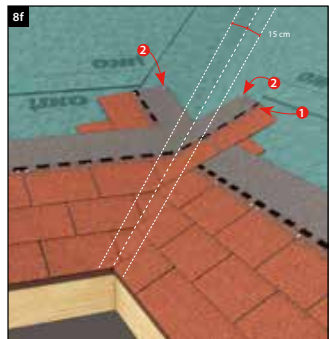
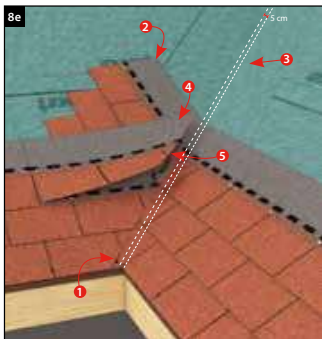
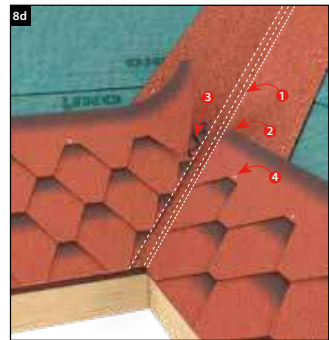
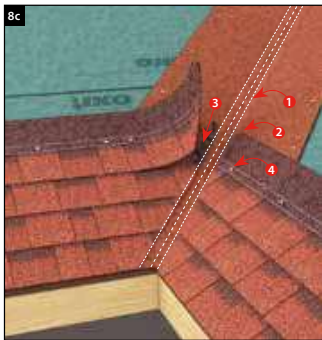
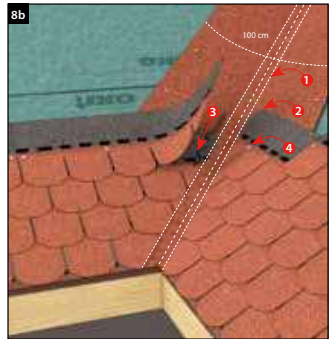
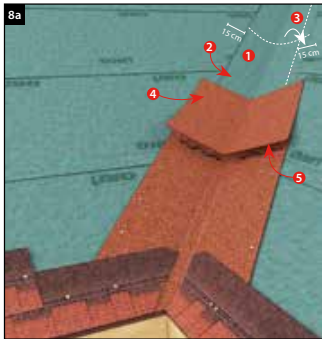

9a

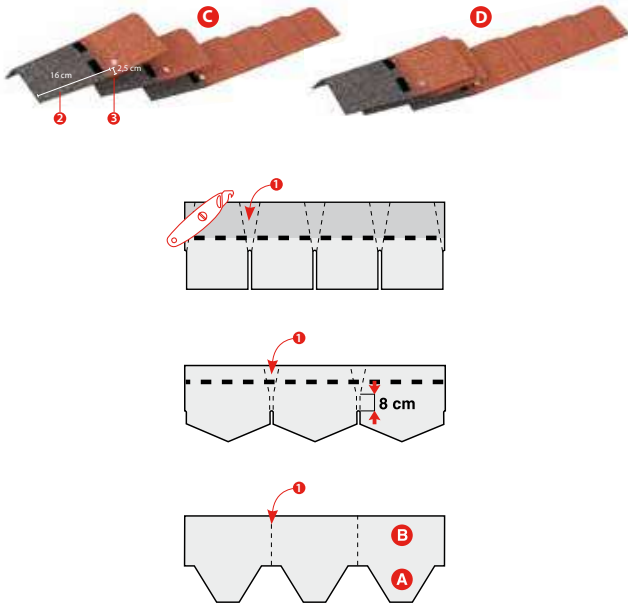

9b



